





F-16A Block 30 Fighting Falcon, J-864, 312 Sqd. RNIAF

Painted in the Royal Netherlands Air Force 75th Anniversary scheme, as it appeared at the Deelen Air Show 1988. Painted in the standard F-16 colours of FS.36270/36118/36375. Paint work in good condition with 'Selotape' like protection film on leading edges of tail fin and tail planes, this is dirty yellow in colour and approx 2"(5cm) wide on real aircraft. All undercarriage units and interiors white. On some occasions smoke generator pods fitted (like Sidewinder AAM without fins), these are gloss white.

Our thanks to the organizers of the Deelen Air Show who allowed us to measure the depicted aircraft in preparation of these decals. Thanks also to R.A.W.E.

-  FS.36118 dark grey
-  FS.36375 light grey
-  FS.36270 medium grey
-  natural metal

paint in red/white/blue striping on top of tail fin.

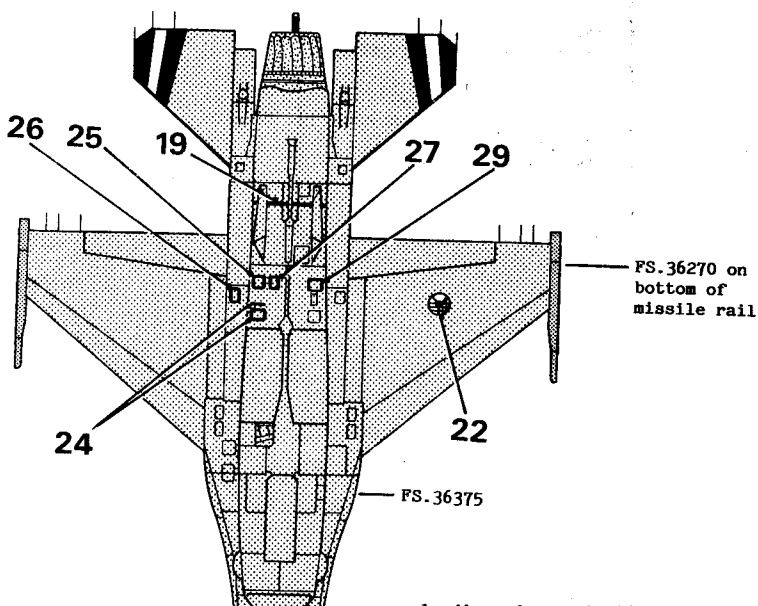
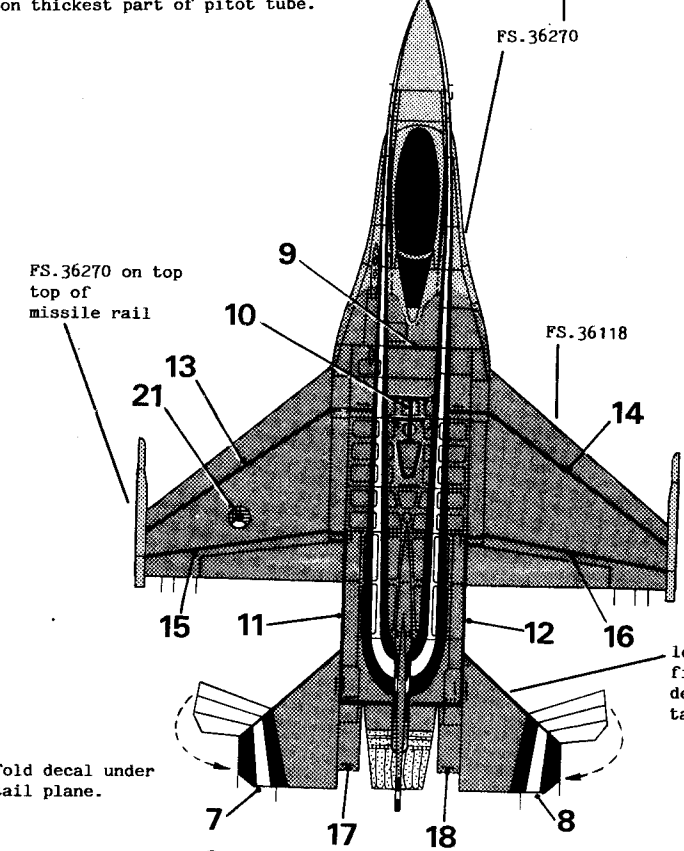
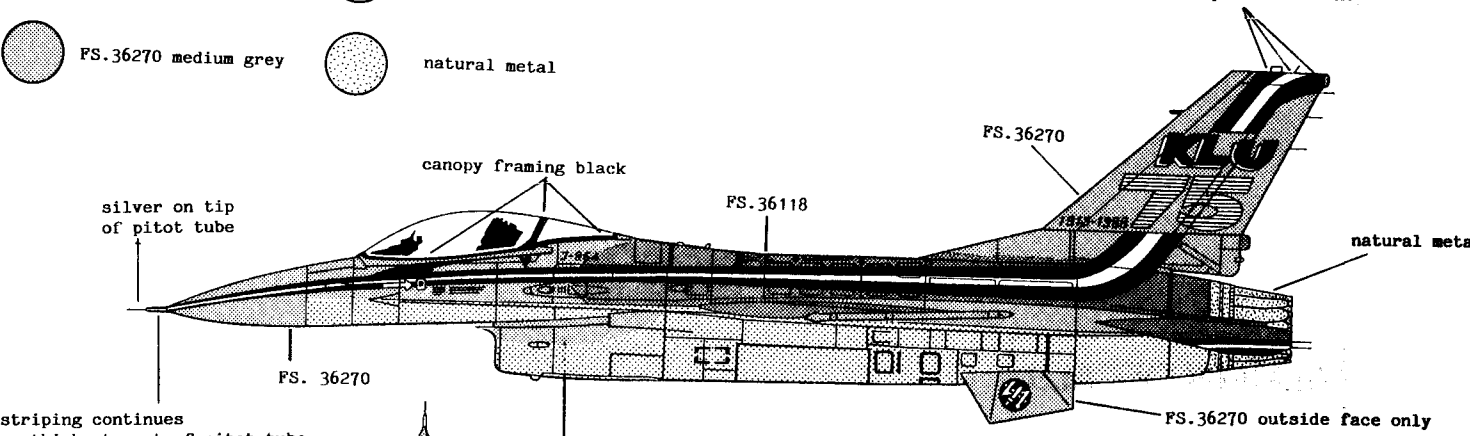

leading edge protection film. Applied over decals. Notes as per tail L/E.

leading edge protection film. slightly dirty yellow in colour approx 2" (5cm) wide on real a/c.

fold decal under tail plane.

